

Article number: 439500380

Description: Rota-fix shaft-hub connection F380x475
Steel

Note: Self centering. Very high torque

Measures

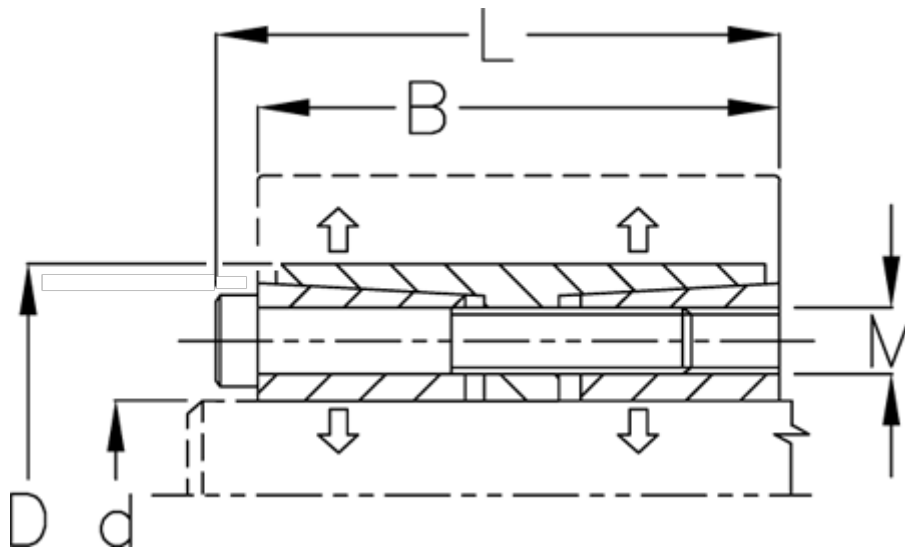

B mm	= 202
d H8 mm	= 380
D mm	= 475
Fit tolerance	= Aksel h8, Nav H8
F kN torque	= 3421.0
L mm	= 224
M mm	= M22
P N/mm ² surface pressure on shaft/hub	= 101

Surface roughness	= R? ? 3.2 µm
T N m torque	= 650000
Ts N m bolt tightening torque	= 930.0